

Optimising diesel hydrotreating catalyst loading scheme

A European refiner used an independent catalyst testing approach to confirm their existing hydrotreating unit's ability to cope with different LCO blending targets

Tiago Vilela and Nattapong Pongboot

Avantium

Refineries process blends of straight-run gasoil (SRGO) and light cycle oil (LCO). LCO is conventionally processed in hydrotreaters along with straight-run middle distillates to upgrade its economic value. From a product quality perspective, LCO has a relatively lower cetane number (poorer ignition performance in diesel engine) compared to straight-run middle distillates derived from the crude distillation unit. The aromatics content (low cetane components, mainly 2-ring aromatics) of LCO from FCC units can be as high as 85 wt% in a high severity FCC operation (such as high-octane gasoline or propylene mode).

Generally, the cetane number of LCOs ranges from 15-25 compared to 40-60 for straight-run diesel. It is also important to note that the cetane number is directly proportional to the total aromatics content.¹ As such, the amount of LCO permitted in the diesel blending pool is often limited by this combustion property, forcing refiners to dispose the remaining LCO to the low-value fuel oil blending pool as the viscosity adjuster. To make matters worse, disposing of LCO as fuel oil is becoming more and more constrained by declining demand for heavy fuel oil as the world is moving towards zero-carbon emissions.

In addition to high aromatics content, a significant portion of organic sulphur (normally 0.2-2.5 wt%) is in the form of alkyl dibenzothiophenes (DBT), while organic nitrogen (typically 100-750 ppmw) is mostly constituted of non-basic organic nitrogen compounds (such as 5-ring membered carbazoles). These organic sulphur and nitrogen components are known to be refractive, posing challenges to ultra-low sulphur diesel (ULSD) operation. In most cases, LCO processing requires more severe hydrotreating (higher temperature) at the start-of-run (SOR) to meet the same product sulphur target (<10 ppmw for ULSD), thus limiting the cycle length. It should be noted that cycle length can also be limited by diesel ASTM colour specifications. It is common for the product colour to deteriorate over time from declined hydrogenation activity.

In general, feeding LCO along with straight-run middle distillates requires higher hydrogen consumption due to hydrogenation of unsaturated hydrocarbon compounds. From a ULSD perspective, a preferred reaction pathway is saturating the first aromatic ring of alkyl DBT (for better sulphur accessibility of metal active sites) prior to the

sulphur removal by hydrogenolysis, thus adding to the total hydrogen consumption (see **Figure 1**). Removal of organic nitrogen compounds, an essential step before converting alkyl DBT, also contributes to the additional hydrogen consumption by increasing the total nitrogen content.

Special grading requirements

In addition to aromatics, the fact that LCO also contains a certain level of olefinic compounds (typically indicated by Bromine number) is a challenge in terms of grading bed design. Catalyst activity must initially be low enough and gradually increase over the reactor length to prevent rapid heat release, local hydrogen starvation, bed fouling from polymerisation, and coke deactivation. This additional special grading requirement can limit the volume of higher-activity hydrotreating catalysts (which is particularly important when processing LCO) when the reactor volume is fixed, such as existing reactors.

To accommodate a high portion of LCO in hydrotreaters, the hydrogen intake capacity must be large enough with adequate reactor volume, hydrogen partial pressure, and hydrogen circulation rate to ensure an acceptable catalyst deactivation rate. With higher temperature rises in the catalytic bed, a higher quenching rate will also be required to maintain catalyst bed thermal stability, thus adding to the

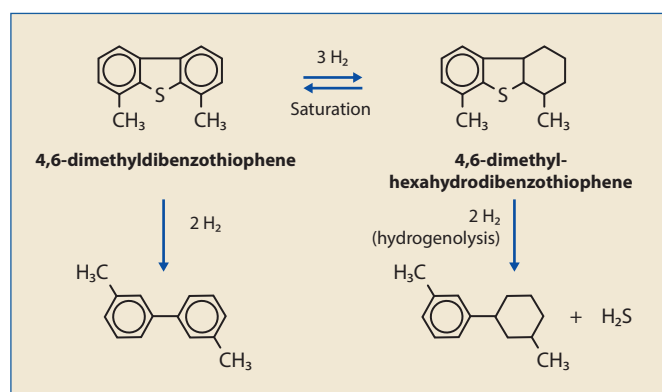

Figure 1 Two sulphur removal pathways: 1) single-step hydrogenolysis (direct) 2) Pre-aromatic ring saturation followed by hydrogenolysis (indirect). The reaction rate of the second pathway is faster for sterically hindered sulphur compounds like alkyl DBT and can further be promoted by using nickel-molybdenum (NiMo) hydrotreating catalysts

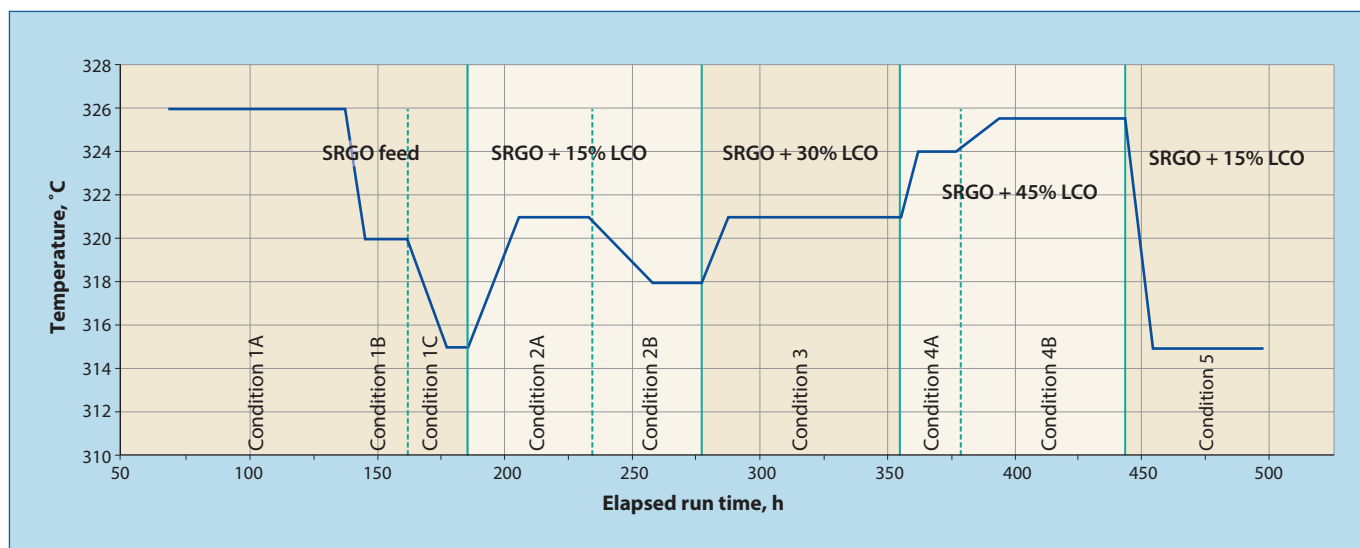

Figure 2 Temperature program followed during the test

total hydrogen circulation rate. Finally, a higher hydrotreating temperature requirement accelerates catalyst deactivation due to a faster coking rate.

These requirements are particularly important for existing hydrotreaters seeking the opportunity to process more LCO, as these old hydrotreating units are often limited in reactor volume, pressure rating, and hydrogen compression capacity. For this, it is important to evaluate the implications of introducing more LCO in diesel hydrotreating units and effectively evaluate the impact on hydrodesulphurisation (HDS) conversion and hydrogen consumption.

Catalyst loading schemes

In demonstrating how independent catalyst testing helped a European refiner confirm their existing hydrotreating unit's ability to cope with different LCO blending targets, it was crucial to focus on hydrogen consumption, cycle length, and aromatics content. Moreover, different catalyst

loading schemes were evaluated to determine which one was the best fit for the existing equipment.

The catalyst evaluation was performed at Avantium laboratories in Amsterdam using a dedicated Refinery Catalyst Testing (RCT) high-throughput unit with 16 parallel reactors employing Avantium's proprietary technology, which will be discussed and described further in **Figure 3**.

The test program consisted of a run of about 20 days (excluding activation) where four ULSD catalyst configurations (CoMo, NiMo, and stacked beds of NiMo + CoMo) loaded in duplicate reactors were exposed to three different feed blends (SRGO + LCO) with three levels of LCO: 15%, 30%, and 45%. The operating temperature was adjusted to reach a product sulphur of around 8 ppm.

The complete set of results obtained from the test was very consistent, showing the expected correlation among different measurements, such as hydrogen consumption, gas make, liquid product density, and product aromatics content. These results, combined with an exceptional reactor-to-reactor repeatability, confirmed the experimental test's validity, relevance, and accuracy.

Experimental

The test program aimed to determine the effect on catalyst performance when processing blended feeds of SRGO + LCO in diesel hydrotreating units at start-of-run conditions (SOR). Eight catalytic systems of CoMo, NiMo, and stacked beds of NiMo + CoMo were exposed to the different blends of SRGO + LCO during a period of 20 days (excluding activation). Different feeds were introduced into the catalysts by changing the amount of LCO blended with the SRGO, while the operating temperature was adjusted at each condition to reach a product sulphur of 8 ppmw – initial temperature estimates were provided by the customer.

The minimum time of stabilisation used after

Properties of the feed blends used during the test				
Feed	100% SRGO	85% SRGO/ 15% LCO	70% SRGO/ 30% LCO	55% SRGO/ 45% LCO
Sulphur, ppmw	5035	4778	4463	4168
Nitrogen, ppmw	77	227	361	482
Density at 15°C, g/ml	0.8422	0.8574	0.8682	0.8878
Aromatic, Mono, wt%	16.3	17.4	18.5	19.6
Aromatic, Di, wt%	7.5	14.1	16.2	20.6
Aromatic, Tri, wt%	0.5	2.9	4.9	7.0
Aromatic, Total, wt%	24.3	34.4	39.6	47.2
SIMDIST, wt%		Boiling temperature, °C		
IBP	111	111	111	111
5	158	168	167	175
10	177	188	189	197
30	223	234	233	243
50	265	274	273	282
70	297	310	311	320
90	334	354	358	373
95	351	373	380	396
FBP	393	429	435	457

Table 1

each temperature adjustment was 24 hours. At least one liquid sample was collected at the end of this period, while the composition of the gas effluent from each reactor was analysed sequentially using a GC analyser (Agilent 7890B). The liquid sampling time was eight hours, so the amount of liquid collected was around 5 ml. The total concentration of sulphur and nitrogen was measured on the liquid product samples using an Xplorer TN/TS analyser according to the standard method ASTM D2622.

All the catalysts evaluated were tested at the same temperature during each condition to compare their performance. The results obtained at the beginning of this test indicated some over-treatment of the feed (product S & N below the detection limit), so the temperature was reduced sequentially, requiring a longer time for stabilisation of the catalyst activity. The temperature program is graphically presented in Figure 2.

Equipment, feedstocks, and reactor loading

The testing program was conducted in a 16-parallel fixed bed reactor system with a reactor diameter of 2.0-2.6 mm. Figure 3 shows a schematic overview of the 16-parallel reactors pilot plant. This unit employs Avantium's proprietary Flowrence technology, which enables tight control of process conditions – temperature, flow rates, and pressure.²

Both the SRGO + LCO liquid feeds and the hydrogen feed gas were equally distributed to the 16 reactors. The pressure of each channel was measured before and after the catalyst bed using electronic pressure sensors. Based on these measurements, the reactor pressures were individually controlled to ensure equal process conditions.

Feedstocks

The feeds used during the test consisted of different blends of SRGO and LCO obtained from the feed of the diesel hydrotreating unit at the customer's refinery. Around 5 litres of three different feed blends were prepared by mixing SRGO and LCO in different proportions (15 vol% LCO, 30 vol% LCO, and 45 vol% LCO). The properties of the feed blends used during the test are presented in Table 1.

Catalyst loading

The catalyst loading schemes were based on the commercial operation of diesel hydrotreating units. Four catalyst configurations were loaded in duplicates in eight reactors,

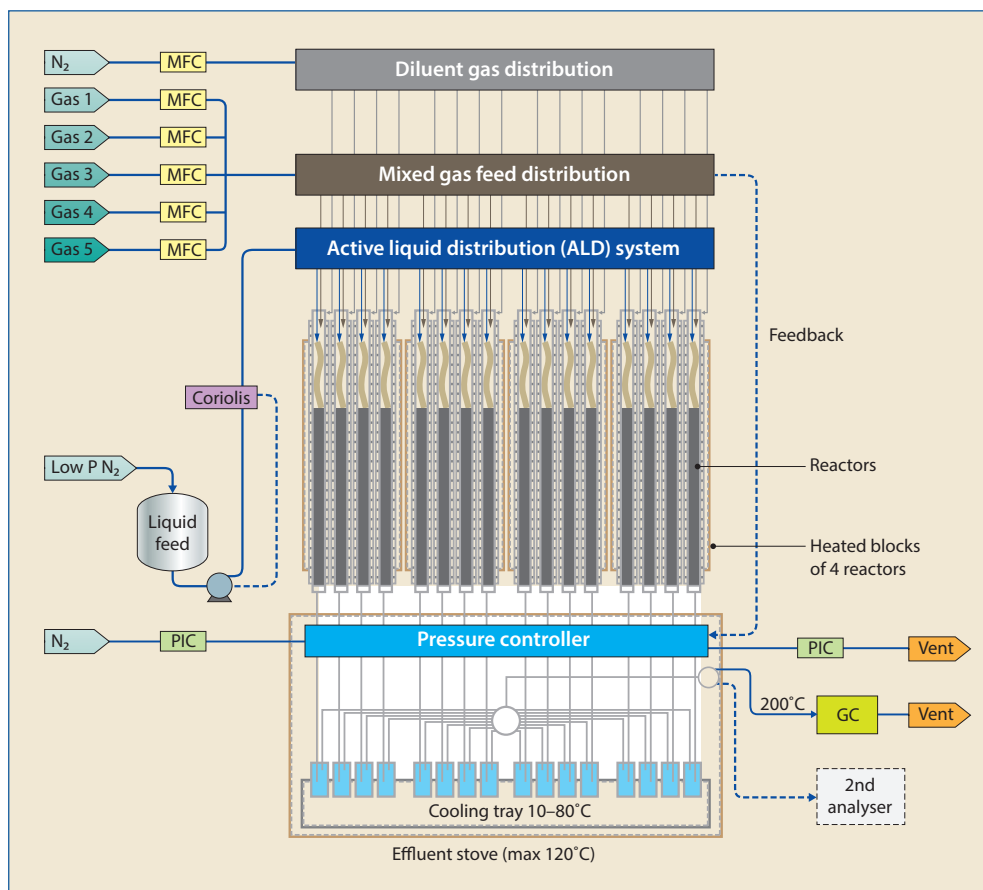

Figure 3 Schematic representation of the Avantium pilot plant with 16 parallel SPSRs

as presented in Figure 4. The amount of catalyst loaded in each reactor (2.0 mm internal diameter) was based on the weight of catalyst required to fill a compact bed of the catalyst, so the required weight of catalyst was calculated using the Compact Bed Density (CBD) according to Equation 1:

$$\text{Weight Catalyst (g)} = \text{Cat. volume target (ml)} * \text{CBD} \left(\frac{\text{g}}{\text{ml}} \right) \quad (1)$$

The targeted volume of catalyst bed was 0.6 ml for all the

It is important to evaluate the implications of introducing more LCO in diesel hydrotreating units and effectively evaluate the impact on HDS conversion and hydrogen consumption

reactors. The actual bed length (catalysts loaded in a single string of pellets stacked on top of each other) for the reactors was around 33 cm. The total number of catalyst particles loaded into each reactor was around 60. No crushing, sieving or other structural change was performed on the catalyst particles before loading. The catalyst particles were carefully loaded into the reactors following Avantium's proprietary single-pellet string reactor (SPSR) loading. Here, the catalyst extrudates are vertically aligned and placed

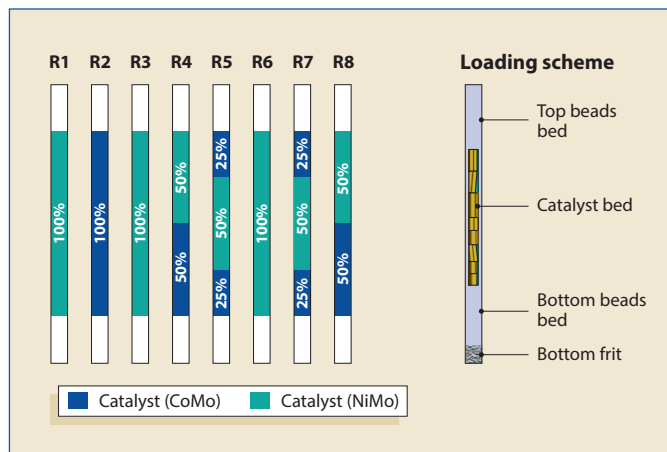

Figure 4 Reactor loading schemes

on top of each other, forming a continuous bed of catalyst with the maximum possible length-to-diameter ratio (see advantages of SPSR in the following discussion) to ensure minimal axial dispersion and the closest behaviour to plug flow. Also, some inert ceramic beads (Zirblast) were used to fill empty spaces between the catalyst particles and the reactor walls (within the catalytic bed) and to provide a top layer of fines for the distribution and mixing of the gas and liquid feeds.

As a best practice, all catalysts were pre-weighed inside the nitrogen glove box after drying to ensure the most accurate catalyst weights before the reactor loading, with a maximum weight deviation (target vs measured) of 0.3%. For this study, the average deviation was only 0.21%.

As shown in Figure 4, different catalyst configurations were tested during the experiment to determine the optimum one. Each catalyst stacking and rationing strategy yielded different levels of relative volume activity (RVA) and total hydrogen consumption. A balance between catalyst activity and hydrogen consumption can be achieved by strategically stacking and rationing both CoMo and NiMo hydrotreating catalysts into a constant reactor volume.

Advantages of SPSR

SPSR units have many advantages. They require far less catalyst and feed. They provide excellent temperature control and reproducible reactor loading because the diameter of the extrudates is slightly smaller than the reactor diameter. In addition, extrudates automatically align as a string of extrudates which, in combination with the narrow reactor, avoids maldistribution of gas and liquid over the catalyst bed, thereby eliminating catalyst bed channelling and incomplete catalyst wetting. When an inert diluent is used, it can be introduced after catalyst pellets are loaded over the full length of the tube, resulting in embedded extrudates but not going between them.

Due to the size and feedstock consumption of such small-scale reactor systems, it becomes feasible to implement these in a compact platform while still operating under relevant conditions. This enables not only the testing of multiple options under identical conditions but also allows for a true replication of tests. This increases data quality and allows the estimation of confidence intervals, thus improving over the more common 'single point' tests.

Results

Four experimental conditions were used to evaluate the catalysts during each run, in addition to the initial lining-out step after the sulphiding of the catalysts. The following section presents a summary of the main results obtained during the evaluation test for comparing catalyst performance with the three levels of LCO: 15%, 30%, and 45%.

Hydrogen consumption

Gas and liquid effluent were measured and analysed during each testing condition (using a specific feed and temperature). GC analysis of the gas effluent (combined with the use of Helium as an internal standard) allowed for estimation of hydrogen consumption at each operating condition. Figure 5 shows the hydrogen consumption results for different catalyst designs evaluated using an SRGO feed blended with different amounts of LCO.

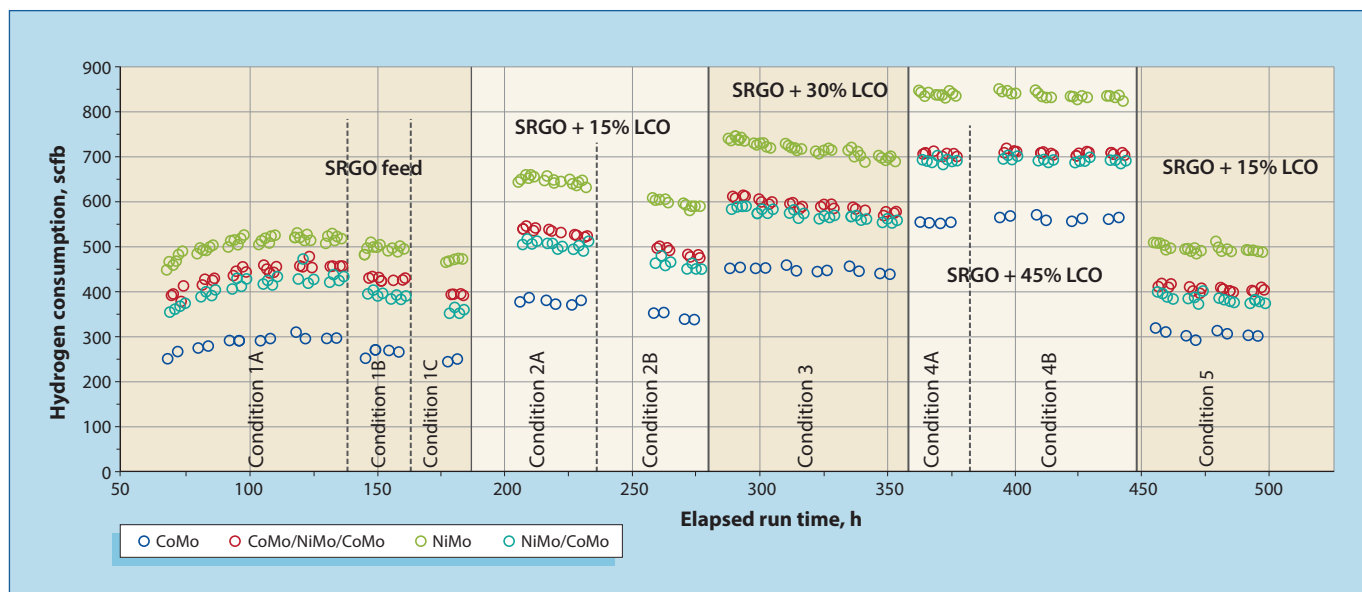

Figure 5 Hydrogen consumption trend

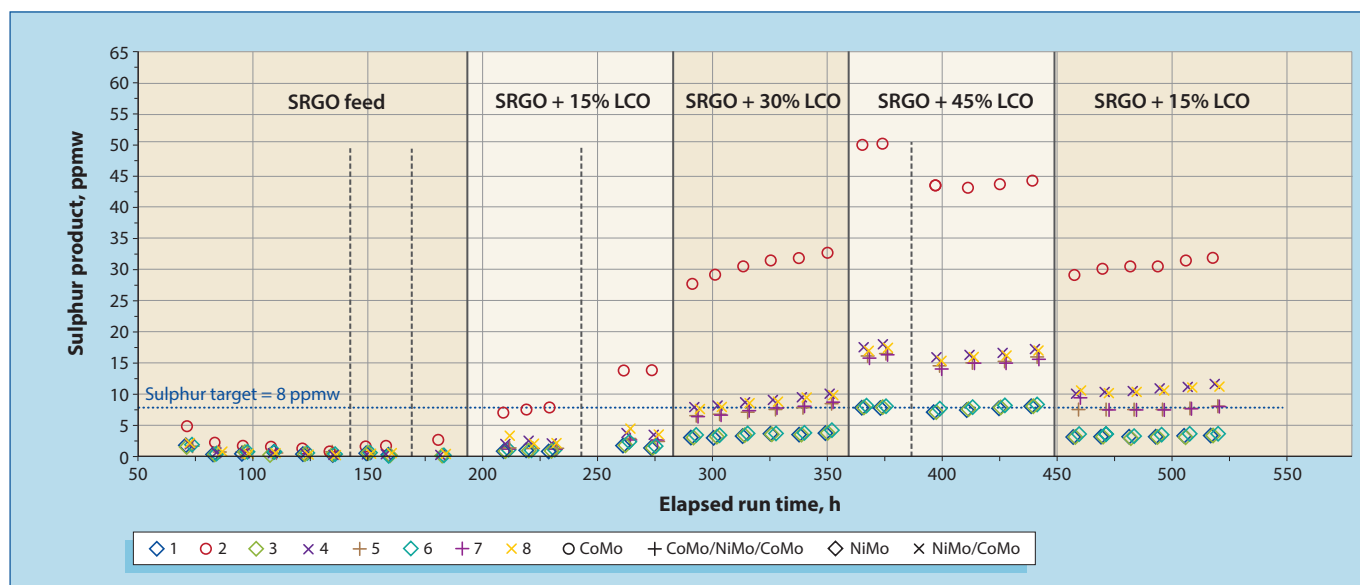

Figure 6 Product sulphur trend

As expected, we can see in Figure 5 that the highest hydrogen consumption during each condition is obtained using the NiMo catalyst, while the CoMo catalyst has the lowest hydrogen consumption. Hydrogen consumption for the NiMo catalyst is almost twice as much as for the CoMo catalyst. This result could be explained by the fact that NiMo catalysts better promote the indirect sulphur removal mechanism, as briefly pointed out in Figure 1. It is a known fact, that NiMo catalysts are inferior to CoMo ones when it comes to hydrodesulphurisation (HDS) activity, therefore shifting the reaction pathway to the pre-aromatic saturation route for better sulphur accessibility.

Additionally, the hydrodearomatisation (HDA) activity of NiMo catalysts is stronger than that of CoMo catalysts, hence there is more aromatics conversion in parallel. Lastly, the extent of nitrogen conversion, which requires pre-aromatic saturation, is also higher for NiMo catalysts from their superior hydrodenitrogenation (HDN) activity. These combined effects substantially increased total hydrogen consumption when 100% NiMo catalysts were used.

Similarly, hydrogen consumption obtained for the mixed catalytic beds (NiMo/CoMo) averaged between the NiMo and CoMo catalysts, with slightly higher consumption (around 5%) obtained in the case of the 'sandwich' configuration CoMo/NiMo/CoMo.

For the NiMo/CoMo configuration, part of the NiMo catalyst was used for direct sulphur removal of easier sulphur species, such as sulphides, thiophenes, and benzothiophenes. These easy sulphur species do not really require pre-aromatics saturation prior to sulphur abstraction (see Figure 1 for mechanism details). As such, this part of the NiMo catalysts consumed approximately the same hydrogen as when using CoMo catalysts for the same purpose.

Consequently, there was less NiMo catalyst volume available for HDN, indirect HDS, and HDA in the subsequent reactor section, thus lowering the total hydrogen consumption (fewer NiMo active sites to promote aromatic saturation). On top of that, more CoMo catalyst volume was available in the last section of the reactor for converting

more difficult sulphur species (alkyl DBT). As such, the direct sulphur abstraction pathway (fewer molecules of hydrogen consumed, also see Figure 1) dominated in this last reactor zone.

In contrast the CoMo/NiMo/CoMo scheme initially utilised CoMo catalyst in the frontal section for the treatment of easy sulphur compounds, leaving more NiMo catalyst volume in the subsequent reactor zone to promote aromatic saturation and effectively convert organic nitrogen compounds (ULSD inhibitor – requires pre-aromatic saturation). The HDS rate is relatively slow in this reactor section as the remaining sulphur species became more sterically hindered (below 500 ppmw level – pre-aromatic saturation route dominates) with relatively high levels of inhibiting organic nitrogen.

The use of CoMo catalyst near the reactor outlet optimised hydrogen consumption in the low nitrogen zone, for example <80 ppmw,³ by promoting direct sulphur abstraction (less hydrogen consumed pathway). The HDS rate for this last zone became much faster than the previous zone as there was less organic nitrogen to inhibit sulphur conversion. This catalyst positioning strategy explains why total hydrogen consumption was slightly higher than NiMo/CoMo stacking, as the NiMo catalyst did more hydrogenation by employing this sandwich design.

Hydrodesulphurisation

The main objective of the ULSD process replicated during this experimental program is to reduce the total sulphur content in the feed below 10 ppmw. For this study, a target product sulphur of 8 ppmw was selected, so the SOR operating temperature was estimated for reaching such conversion.

As already mentioned, the initial temperature provided was overestimated, causing overtreatment of the feed (very low sulphur product), so this was immediately adjusted to reach the desired product sulphur.

Figure 6 shows the profile of the sulphur product obtained during the test. A slightly rising trend in product sulphur was observed during most of the operating conditions,

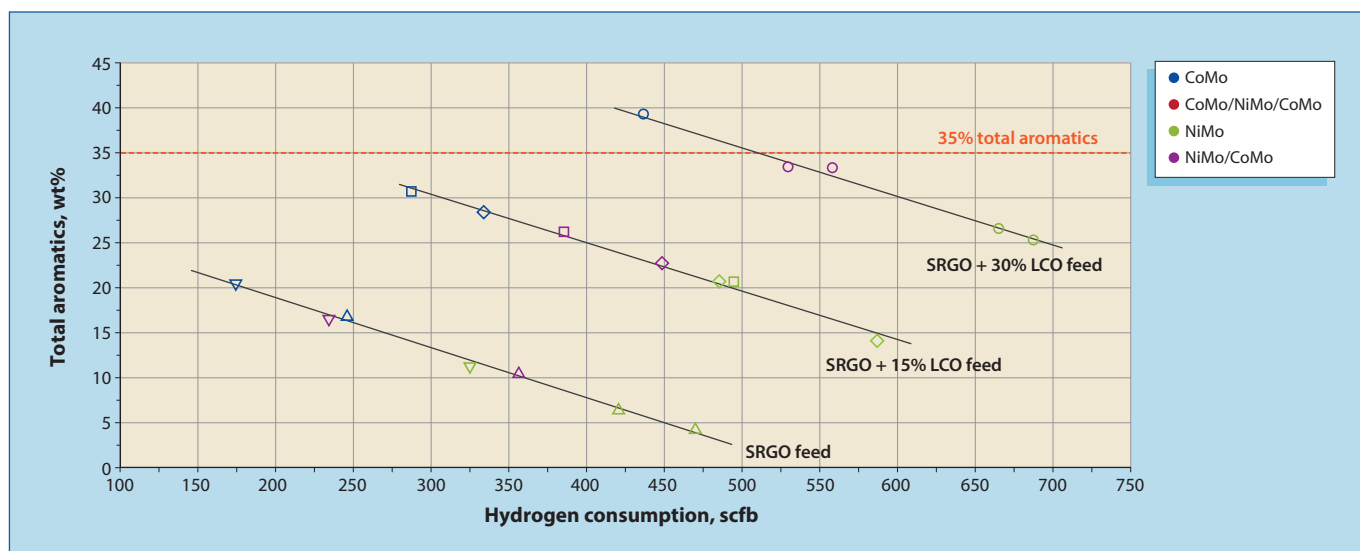

Figure 7 Total aromatics content in the liquid products

which seems to indicate a small variation in catalyst activity with time. As expected, this trend was also observed in hydrogen consumption (see Figure 5).

NiMo catalyst presented the highest HDS capacity during all the conditions tested, followed by the CoMo/NiMo/CoMo and NiMo/CoMo systems. As previously observed with hydrogen consumption, the CoMo catalyst showed the lowest activity.

This finding suggests CoMo/NiMo/CoMo as an optimal loading scheme with a good balance between catalyst activity and hydrogen consumption. This conclusion draws on the fact that the right catalyst type was used for the right purpose at the right reactor position when the ratio between CoMo/NiMo is fixed (constant catalyst loading cost), 50/50% in this case study. As illustrated in Figure 6, the CoMo/NiMo/CoMo scheme achieved the ULSD sulphur specification, 8 ppmw, at 30% LCO blending percentage (a practical limit to achieve the minimum cetane number for modern road diesel) with a relatively low SOR temperature (321°C, see Figure 2) and only a marginal increase (5%) in hydrogen consumption (see Figure 5).

In the CoMo/NiMo/CoMo scheme, the low nitrogen zone can be achieved earlier with more NiMo catalyst volume available for HDN reactions, as the first half of the CoMo catalyst is used for easy sulphur treatment near the reactor inlet. Generally, the HDS rate is the highest in the reactor region with low nitrogen levels, so overall RVA increases with the enlarged low nitrogen zone. In the hydrogen constrained units, the last portion of CoMo can be placed near the reactor outlet to optimise hydrogen use further. Moreover, placing CoMo catalysts near the reactor outlet offers better stability for hydrotreating units with a relatively low pressure rating. The hydrogen partial pressure drops along the reactor axis, and CoMo works better when the hydrogen partial pressure is below 40 bara (less hydrogen available for promoting the indirect sulphur removal pathway).

Product aromatics and density

During hydrotreating, unsaturated hydrocarbon molecules (olefins and aromatics) are usually partially hydrogenated, which affects global hydrogen consumption. Because of

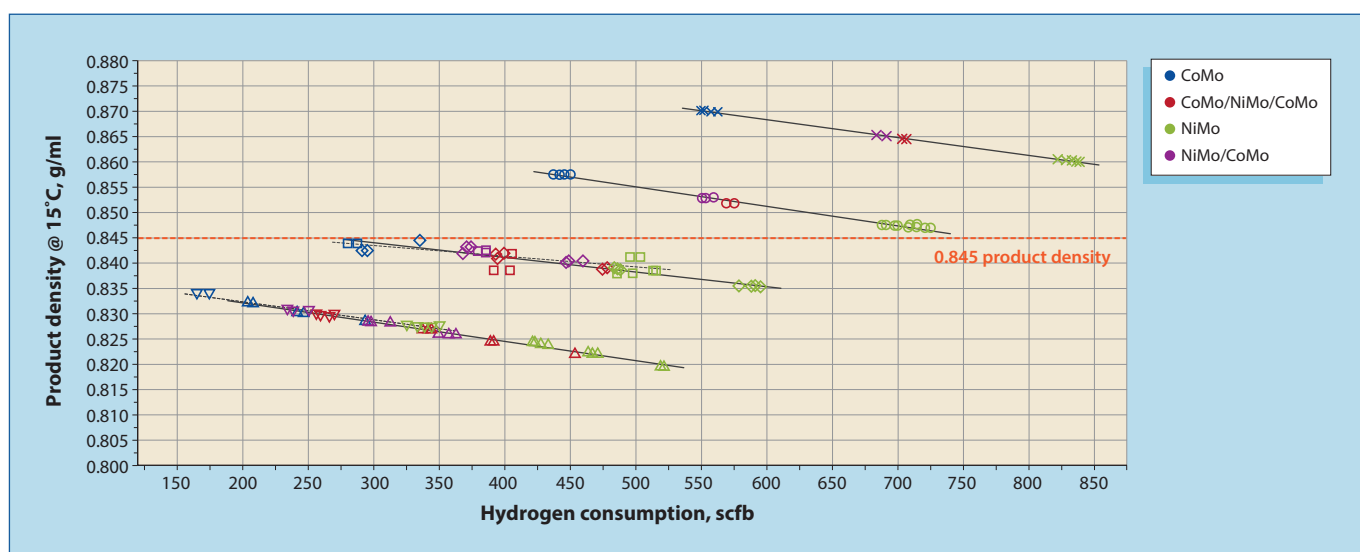

Figure 8 Density of the liquid products

this, the complete characterisation of feeds and products in a hydrotreating process, including aromatics content, is very important. Most importantly, aromatics content is an indirect indicator of cetane number and product density, the most prevalent constraints when processing LCO.

Figure 7 shows a comparison of the trends of the total aromatics content measured on the liquid product for the different feeds and catalysts evaluated in the test. In general, the total aromatics content in the product increased with the amount of LCO blended into the feed and decreased when operating at higher conversions/higher hydrogen consumption.

In the same way, the 100% NiMo scheme produced the highest conversion level of aromatics (higher hydrogenation activity), yielding the highest degree of cetane number uplift at the expense of higher hydrogen consumption. In contrast, the 100% CoMo extreme produced the lowest aromatics saturation, hence the lowest cetane number improvement.

In general, LCO hydrotreating is a less efficient way of improving cetane number compared with LCO hydrocracking for the same amount of hydrogen consumed. As such, the degree of aromatic saturation should be balanced and optimised by the principle of catalyst rationing and stacking, as earlier explained, with careful consideration of the maximum LCO blending ratio. The maximum practical blending ratio of 30% is a practical upper limit for conventional diesel hydrotreating, with typically a 2-10 cetane number improvement to meet modern road diesel standards.

As suggested, the LCO blending percentage should be limited to approximately 30% for this hydrotreater to ensure the aromatics content is not greater than 35%, which corresponds to a minimum cetane index of 46 (with a potential 5 cetane number upgrading by using cetane improver.¹) When the NiMo/CoMo scheme was evaluated for this LCO blending ratio, the total aromatics was 33%. Although the aromatic content of CoMo/NiMo/CoMo is not presented here (see **Figure 8**), it should be lower than that of the NiMo/CoMo scheme (33 wt%), with only a 5% increase in hydrogen consumption.

Using CoMo alone would not comply with this aromatics limit, while a 100% NiMo scheme could result in excessive hydrogen consumption (almost a 30% increase compared with NiMo/CoMo and CoMo/NiMo/CoMo).

From a product density perspective, the LCO blending limit becomes even more stringent to comply with the maximum density allowed by the EU directive: 0.845 g/ml.⁴ According to **Figure 8**, the LCO blending limit is approximately 15% for every catalyst loading scheme involved in this experiment. It must be noted that around 20% LCO blending percentage can also be achieved in terms of product density by extrapolation but limits the viable options to NiMo, NiMo/CoMo, and CoMo/NiMo/CoMo.

These results again suggest the need to optimise the CoMo/NiMo ratio and positioning for optimum performance of hydrogen-constrained hydrotreaters, as suggested by catalyst suppliers. For a hydrogen-constrained hydrotreater, the use of CoMo/NiMo/CoMo scheme is

highly recommended as a reconciliation between hydrogen consumption, catalyst activity, and product qualities by employing the right catalyst for the right objective at the right location in the hydrotreating reactor.

If the refiner is looking to process a higher blending ratio, LCO hydrocracking is optimally recommended to efficiently boost the cetane number by naphthene ring opening. All the results presented in **Figure 5** (hydrogen consumption), **Figure 7** (aromatics content), and **Figure 8** (product density) are consistent and aligned with expected trends. This complete set of results confirms the quality of the data produced during the test and the high accuracy of the experimental setup used.

Key takeaway

Refiners should carefully evaluate the options for LCO upgrading to ensure a good balance of cycle length, hydrogen consumption, and product qualities. Independent catalyst testing is proven to be an effective tool for providing refiners with confidence in selecting the final solution, as demonstrated in this study.

Flowrence is a mark from Avantium.

Acknowledgements

Theo Groen and Driss Boublali – Operations; Thomas Oosterhoff and Nicholas Roffrey – Catalyst loading and lab testing; Imko Juffermans and Daniel Banen – Analytics.

References

- 1 Sharafutdinov, I., Stratiev, D., Shishkova, I., Dinkov, R., Pavlova, A., Petkov, P., Rudnev, N., Dependence of Cetane Index on Aromatic Content in Diesel Fuels, *Oil Gas European Magazine*, 38(3), Sept 2012, 148-152.
- 2 Ortega C., D. O.-J. *Can. J. of Chem. Eng.*, 99, 2021, 1288-1306.
- 3 Meneses-Ruiz, E., Escobar, J., Juventino Mora, R., Ascención Montoya, J., Barrera, M. C., Solís-Casados, D., Escobar-Alarcón, L., Del Ángel, P., Laredo, G., Nitrogen compounds removal from oil-derived middle distillates by MIL-101(Cr) and its impact on ULSD production by hydrotreating, *Oil & Gas Science and Technology - Revue de l'IFP*, 76(1), Jan 2021, 56.
- 4 EU: Fuels: Diesel and Gasoline, TransportPolicy.net, www.transport-policy.net/standard/eu-fuels-diesel-and-gasoline

Tiago Vilela is Director Refinery Catalyst Testing at Avantium, accountable for the overall performance of the business line. He has more than 20 years' experience in engineering, project management, management consultancy, and business development. He holds an MSc degree in chemical engineering from the University of Aveiro, Portugal, and a Professional Doctorate in engineering from Delft University of Technology, The Netherlands.

Email: Tiago.Vilela@avantium.com

Nattapong Pongboot is a Project Manager in the Refinery Catalyst Testing group at Avantium, delivering high-quality catalyst testing services for customers worldwide. He has hands-on experience in refining and petrochemical technologies as both a licensor and refiner. He holds an M.Eng. degree in chemical engineering from Kasetsart University.

Email: Nattapong.Pongboot@avantium.com